

Dimension Guide

Fixed Speed Air Conditioner

Model:
ESM09CRR-B3

Dimensions			
	width	height	depth
Product (mm)	700	285	200

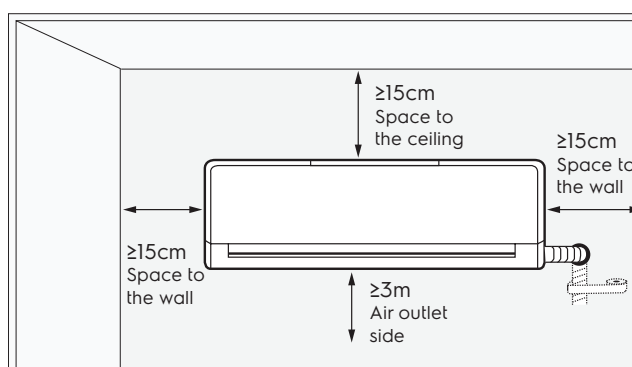
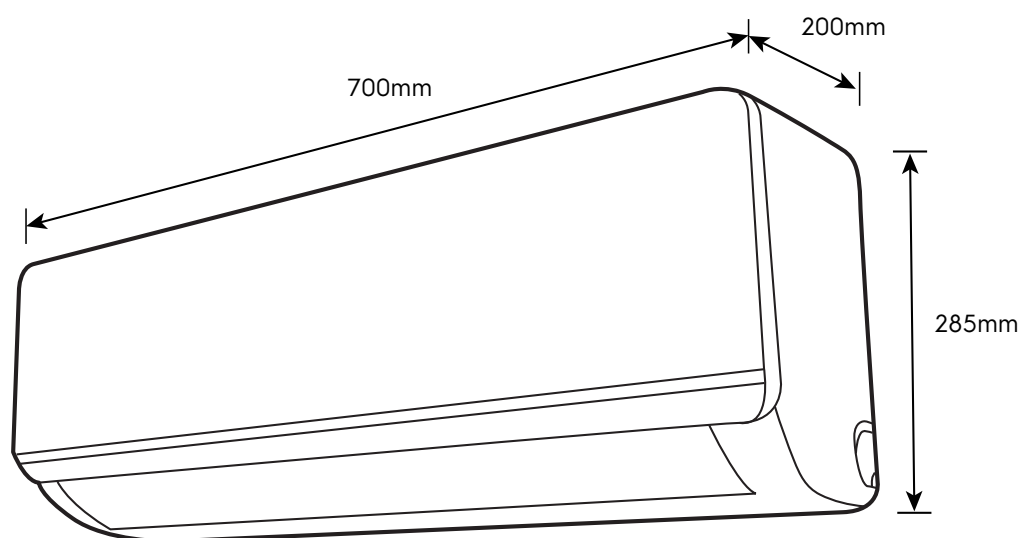

Please note! Dimensions to be used as a guide only. All customers MUST refer to the user manual supplied with the product for detailed installation instructions.
© 2022 Electrolux S.E.A PTE. LTD. E_DIM_ESM09CRR-B3_Feb22